

Cold Air Generator Jet Cooler

JET COOLER

RoHS Compliance

~ R Series ~



NIHON SEIKI

Resin Cooler Released



Easy cooling of everything

BN-VT300R

Just by supplying compressed air
it ejects cold jet air up to **30°C** colder than inlet air.

Features

1. Because it is made of resin, it is lightweight and compact.
2. Does not use refrigerant or electricity. Long Life.
3. Easy to use. Add mounting hole.
4. Panel installation possible.
5. Silencer can be installed on the cold air side.
6. Piping on the hot air side is possible. ※Be careful of burns

Usage

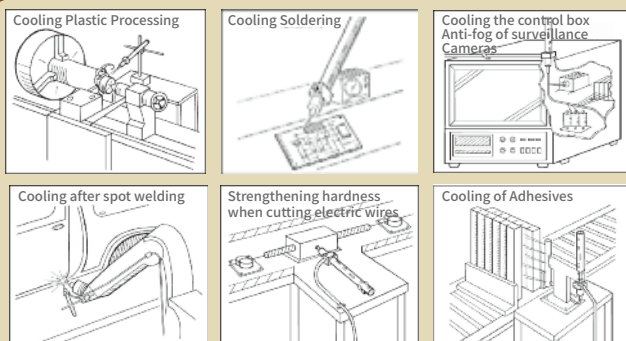

Principle

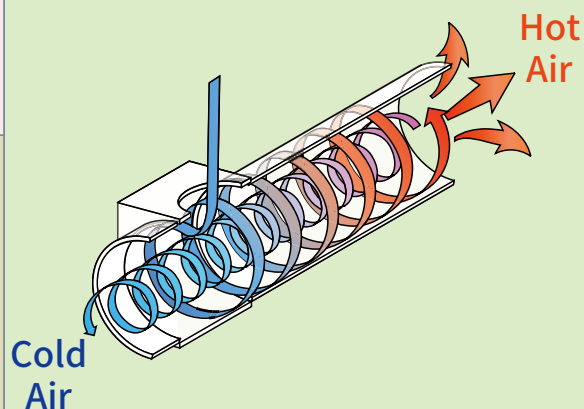

Jet cooler is a cold air generator, applying a principle of swirling theory, which does not have any moving parts.

Model name example

▼Jet Cooler Body

BN - VT 300R

Jet Cooler Model

300R : Resin Type

▼Options

BN - VT 30 M

Applicable Jet Cooler

30 For VT300R

Options

M	Magnet Table (with connecting joint)
H	Flexible Hose (with insulation)
J	Hose Joint
S	Silencer (for cold air side)

※ The silencer and flexible hose cannot be installed at the same time.

Specifications

▼Specifications

Supply Pressure	0.2 ~ 0.5MPa
Weight	90g

▼Air Consumption

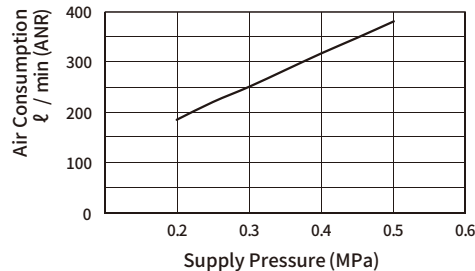

▼Performance

Inlet Air Pressure (MPa)	Drop Temperature (°C)	Cold Air Volume L/Min (ANR)	Cooling Capacity (W)
0.2	26.9	89	48
0.25	28.8	112	65
0.3	29	128	75
0.35	29.9	145	87
0.4	30.7	159	98
0.45	31.1	175	110
0.5	31.5	191	127

Dimensions

▼BN-VT300R

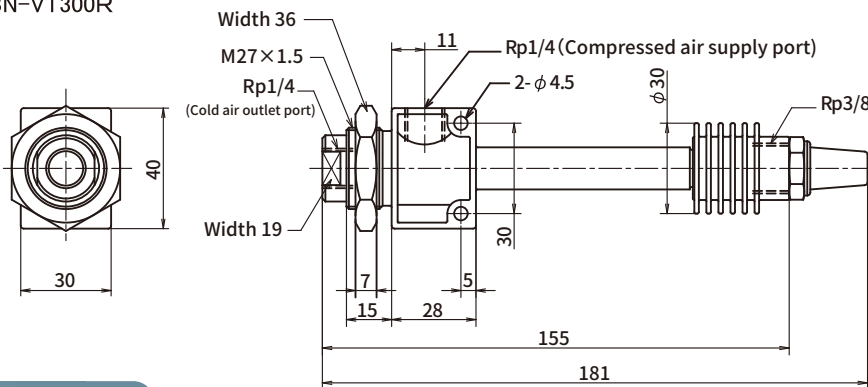

(unit : mm)

※ Rp is a parallel female screw for a tapered male screw for a pipe.

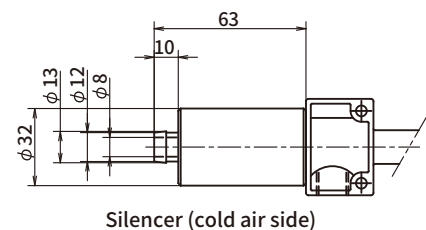

Silencer (cold air side)

Options

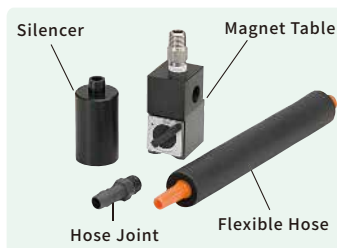

Option	Item	
Magnet Table	Connection	Rc1/4
	Dimensions(WxDxH)	30×39×63
	Weight(kg)	0.3
Flexible Hose (with insulation)	Connection	R1/4
	Nozzle Dia.(mm)	φ6
	Length(mm)	約200
Hose Joint	Dimensions(mm)	Refer to the left (when installing the hose joint)
	Hose Inner Dia.(mm)	φ10
Silencer	Dimensions	See dimension table above
	Silencing effect	Reduced by 8 to 12 dB (Depends on the amount of cold air)
	Weight(g)	35

※ The length of the flexible hose is the length from the screwed part of the main body to the tip of the nozzle.

※ When using flexible hoses and hose joints, make sure that the cold air temperature does not drop below -20 °C.

※ Silencer and flexible hose cannot be installed at the same time.

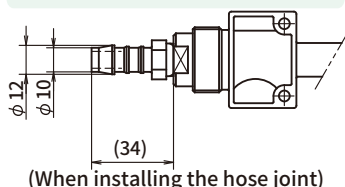

(When installing the hose joint)

Related Products



N Series
Drop Temp. -40°C



K Series
Drop Temp. -60°C

日本精器株式会社

URL: <http://www.nihonseiki.com>

本社・工場 〒581-0016 大阪府八尾市八尾木北2丁目8番地
TEL.072-923-0481 FAX.072-994-3603

大阪営業所 〒581-0016 大阪府八尾市八尾木北2丁目8番地
TEL.072-923-0481 FAX.072-994-3603

東京営業所 〒143-0027 東京都大田区中馬込1丁目16番23号
TEL.03-3777-6111 FAX.03-3777-6116

名古屋営業所 〒460-0022 愛知県名古屋市中区金山5丁目11番6号
名古屋外ヶ丘ビル3階3B-3
TEL.052-884-7582 FAX.052-884-7583



- Please make sure that air filters and regulators are equipped with the air line system.
- For use in cold temperature, use an air dryer to prevent freezing.
- For correct handling, read the instruction manual before installing.
- Please use it so that the main body temperature does not exceed 80°C. Please use the K series if it is over 80°C.
- Be careful of burns on the hot air side



JOEUN INTERNATIONAL

Japan - Osaka
2 Chome-9-22 Kashitanishi, Higashiōsaka-shi, Ōsaka-fu, Japan
TEL : (+81) 06-7708-4707

Republic of Korea - Seoul
Meca-Zone 223, 117, Hwanggeum-ro, Yangchon-eup, Gimpo-si, Gyeonggi-do
TEL : (+82) 02-899-0318 FAX : (+82) 02-899-0313

www.joeeun-intl.com

Email : verbenabys@hanmail.net